



**RF360**  
**Europe GmbH**

## **SAW components**

### **SAW RF downlink filter**

Small cell & femtocell

LTE band 1

Series/type:	B9622
Ordering code:	B39212B9622P810
Date:	April 05, 2018
Version:	2.3

RF360 products mentioned within this document are products of RF360 Europe GmbH and other subsidiaries of RF360 Holdings Singapore Pte. Ltd. (collectively, the "RF360 Subsidiaries").

RF360 Europe GmbH, Anzinger Str. 13, München, Germany

© 2019 RF360 Europe GmbH and/or its affiliated companies. All rights reserved.

These materials, including the information contained herein, may be used only for informational purposes by the customer. The RF360 Subsidiaries assume no responsibility for errors or omissions in these materials or the information contained herein. The RF360 Subsidiaries reserve the right to make changes to the product(s) or information contained herein without notice. The materials and information are provided on an AS IS basis, and the RF360 Subsidiaries assume no liability and make no warranty or representation, either expressed or implied, with respect to the materials, or any output or results based on the use, application, or evaluation of such materials, including, without limitation, with respect to the non-infringement of trademarks, patents, copyrights or any other intellectual property rights or other rights of third parties.

No use of this documentation or any information contained herein grants any license, whether express, implied, by estoppel or otherwise, to any intellectual property rights, including, without limitation, to any patents owned by QUALCOMM Incorporated or any of its subsidiaries.

Not to be used, copied, reproduced, or modified in whole or in part, nor its contents revealed in any manner to others without the express written permission of RF360 Europe GmbH.

Qualcomm is a trademark of Qualcomm Incorporated, registered in the United States and other countries. Other product and brand names may be trademarks or registered trademarks of their respective owners.

This technical data may be subject to U.S. and international export, re-export, or transfer ("export") laws. Diversion contrary to U.S. and international law is strictly prohibited.

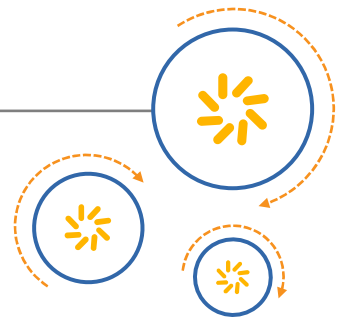

RF360 Europe GmbH  
A Qualcomm – TDK Joint Venture

## SAW components

### SAW RF downlink filter

Small cell & femtocell  
LTE band 1

Series/type:	B9622
Ordering code:	B39212B9622P810
Date:	April 05, 2018
Version:	2.3

RF360 products mentioned within this document are offered by RF360 Europe GmbH and other subsidiaries of RF360 Holdings Singapore Pte. Ltd. (collectively, the “RF360 Subsidiaries”).

RF360 Holdings Singapore Pte. Ltd. is a joint venture of Qualcomm Global Trading Pte. Ltd. and EPCOS AG.

RF360 Europe GmbH, Anzinger Str. 13, München, Germany

© 2018 RF360 Europe GmbH and/or its affiliated companies. All rights reserved.

These materials, including the information contained herein, may be used only for informational purposes by the customer. The RF360 Subsidiaries assume no responsibility for errors or omissions in these materials or the information contained herein. The RF360 Subsidiaries reserve the right to make changes to the product(s) or information contained herein without notice. The materials and information are provided on an AS IS basis, and the RF360 Subsidiaries assume no liability and make no warranty or representation, either expressed or implied, with respect to the materials, or any output or results based on the use, application, or evaluation of such materials, including, without limitation, with respect to the non-infringement of trademarks, patents, copyrights or any other intellectual property rights or other rights of third parties.

No use of this documentation or any information contained herein grants any license, whether express, implied, by estoppel or otherwise, to any intellectual property rights, including, without limitation, to any patents owned by QUALCOMM Incorporated or any of its subsidiaries.

Not to be used, copied, reproduced, or modified in whole or in part, nor its contents revealed in any manner to others without the express written permission of RF360 Europe GmbH.

Qualcomm and Qualcomm RF360 are trademarks of Qualcomm Incorporated, registered in the United States and other countries. RF360 is a trademark of Qualcomm Incorporated. Other product and brand names may be trademarks or registered trademarks of their respective owners.

This technical data may be subject to U.S. and international export, re-export, or transfer (“export”) laws. Diversion contrary to U.S. and international law is strictly prohibited.

<b>SAW components</b>	<b>B9622</b>
<b>SAW RF downlink filter</b>	<b>2140 MHz</b>

Data sheet

**Table of contents**

1 <a href="#">Application</a> .....	4
2 <a href="#">Features</a> .....	4
3 <a href="#">Package</a> .....	5
4 <a href="#">Pin configuration</a> .....	5
5 <a href="#">Matching circuit</a> .....	6
6 <a href="#">Characteristics</a> .....	7
7 <a href="#">Maximum ratings</a> .....	9
8 <a href="#">Transmission coefficient</a> .....	10
9 <a href="#">Reflection coefficients</a> .....	11
10 <a href="#">EVM</a> .....	12
11 <a href="#">Packing material</a> .....	13
12 <a href="#">Marking</a> .....	16
13 <a href="#">Soldering profile</a> .....	17
14 <a href="#">Annotations</a> .....	18
15 <a href="#">Cautions and warnings</a> .....	19
<a href="#">Important notes</a> .....	20

Data sheet

## 1 Application

- Low-loss SAW duplexer for 3G/LTE small cell & femtocell systems (Band 1)
- Usable pass band 60 MHz
- High power durability

## 2 Features

- Industrial grade qualified family
- Package size 1.4±0.1 mm × 1.1±0.1 mm
- Package height 0.45 mm (max.)
- Approximate weight 3 mg
- RoHS compatible
- Package for Surface Mount Technology (SMT)
- Ni/Au-plated terminals
- Electrostatic Sensitive Device (ESD)
- Moisture Sensitivity Level 2a (MSL2a)

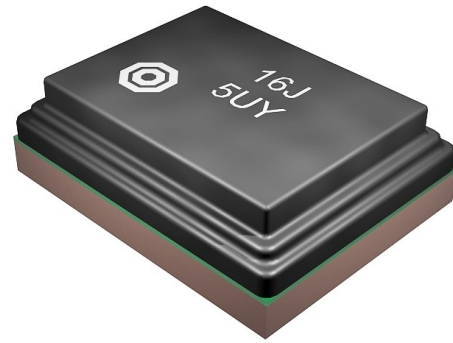

**Figure 1:** Picture of component with example of product marking.

**SAW components** **B9622**  
**SAW RF downlink filter** **2140 MHz**

Data sheet

**3 Package**

BOTTOM VIEW

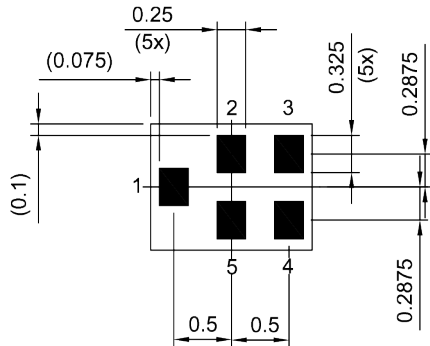

Pad and pitch tolerance ±0.05

**4 Pin configuration**

- 1            Input
- 4            Output
- 2, 3, 5      Ground

SIDE VIEW

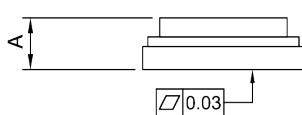

TOP VIEW

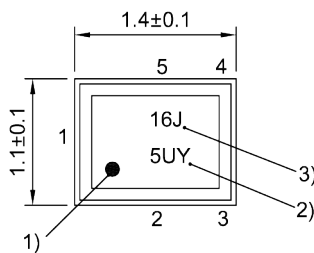

- 1) Marking for pad number 1
- 2) Example of encoded lot number
- 3) Example of encoded filter type number

Land pattern THRU VIEW

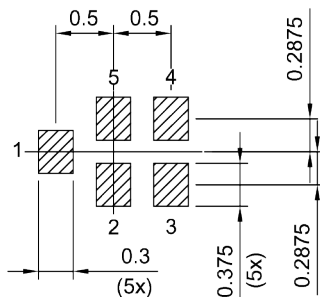

Landing pad tolerance -0.02

**Figure 2:** Drawing of package with package height A = 0.45 mm (max.). See Sec. Package information (p. 19).

Data sheet

## 5 Matching circuit

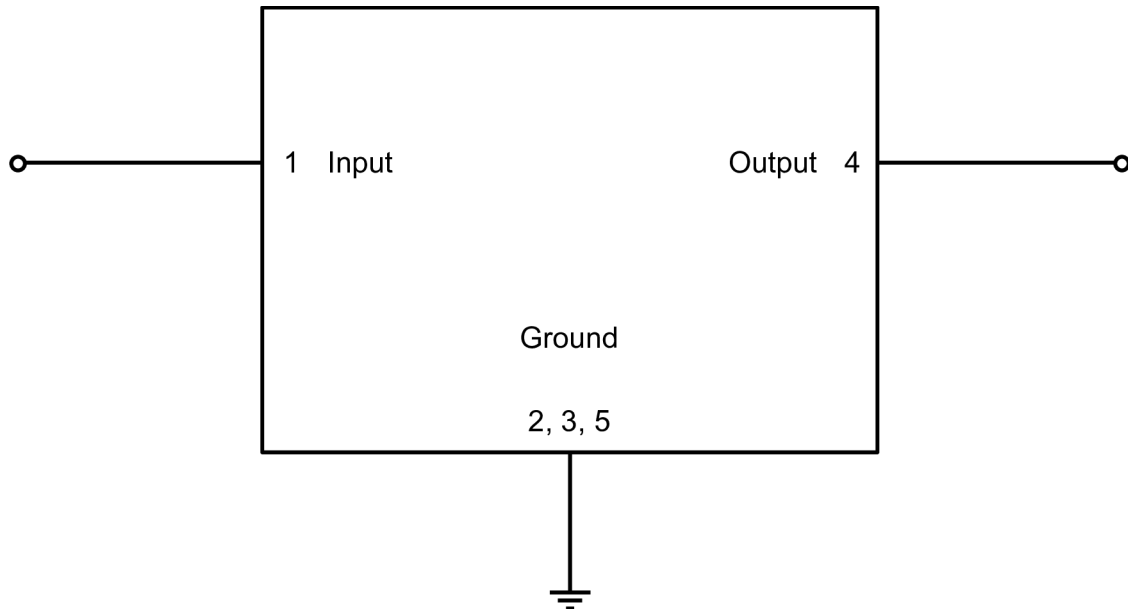

**Figure 3:** Schematic of matching circuit. No external matching components required.



## SAW components

B9622

## SAW RF downlink filter

2140 MHz

Data sheet

## 6 Characteristics

Temperature range for specification	$T_{SPEC}$	= -10 °C ... +85 °C
Input terminating impedance	$Z_{IN}$	= 50 $\Omega$
Output terminating impedance	$Z_{OUT}$	= 50 $\Omega$

Characteristics			min. for $T_{SPEC}$	typ. @ +25 °C	max. for $T_{SPEC}$		
<b>Center frequency</b>		$f_C$	—	2140	—	MHz	
<b>Maximum insertion attenuation</b>	2110... 2170	MHz	$\alpha_{max}$	—	2.0	2.5	dB
<b>Amplitude ripple (p-p)</b>	2110... 2170	MHz	$\Delta\alpha$	—	0.8	1.4	dB
<b>Maximum VSWR</b>			VSWR <sub>max</sub>				
@ input port	2110... 2170	MHz	—	1.8	2.1		
@ output port	2110... 2170	MHz	—	1.8	2.1		
<b>Maximum error vector magnitude</b>	2112.4... 2167.6	MHz	EVM <sub>max</sub> <sup>1)</sup>	—	1.5	2.5	%
<b>Minimum attenuation</b>			$\alpha_{min}$				
	50... 1710	MHz		20	35	—	dB
	1710... 1785	MHz		35	38	—	dB
	1805... 1880	MHz		25	40	—	dB
	1920... 1980	MHz		35	43	—	dB
	2400... 2484	MHz		30	45	—	dB
	2500... 2570	MHz		30	45	—	dB
	2620... 2690	MHz		25	46	—	dB
	5150... 5850	MHz		13	21	—	dB

<sup>1)</sup> Error Vector Magnitude (EVM) based on definition in 3GPP TS 25.141.

## SAW components

B9622

## SAW RF downlink filter

2140 MHz

## Data sheet

Temperature range for specification	$T_{SPEC}$	= -40 °C ... +95 °C
Input terminating impedance	$Z_{IN}$	= 50 $\Omega$
Output terminating impedance	$Z_{OUT}$	= 50 $\Omega$

Characteristics <sup>1)</sup>				min. for $T_{SPEC}$	typ. @ +25 °C	max. for $T_{SPEC}$	
<b>Center frequency</b>			$f_C$	—	2140	—	MHz
<b>Maximum insertion attenuation</b>	2110... 2170	MHz	$\alpha_{max}$	—	2.0	2.6	dB
<b>Amplitude ripple (p-p)</b>	2110... 2170	MHz	$\Delta\alpha$	—	0.8	1.5	dB
<b>Maximum VSWR</b>			VSWR <sub>max</sub>				
@ input port	2110... 2170	MHz		—	1.8	2.1	
@ output port	2110... 2170	MHz		—	1.8	2.1	
<b>Maximum error vector magnitude</b>	2112.4... 2167.6	MHz	EVM <sub>max</sub> <sup>2)</sup>	—	1.5	2.5	%
<b>Minimum attenuation</b>			$\alpha_{min}$				
	50... 1710	MHz		20	35	—	dB
	1710... 1785	MHz		35	38	—	dB
	1805... 1880	MHz		25	40	—	dB
	1920... 1980	MHz		35	43	—	dB
	2400... 2484	MHz		30	45	—	dB
	2500... 2570	MHz		30	45	—	dB
	2620... 2690	MHz		25	46	—	dB
	5150... 5850	MHz		13	21	—	dB

<sup>1)</sup> Valid for parts tested after 5<sup>th</sup> April 2018.

<sup>2)</sup> Error Vector Magnitude (EVM) based on definition in 3GPP TS 25.141.

## SAW components

B9622

## SAW RF downlink filter

2140 MHz

Data sheet

## 7 Maximum ratings

Operable temperature	$T_{OP} = -40\text{ °C} \dots +95\text{ °C}$	
Storage temperature	$T_{STG}^{1)} = -40\text{ °C} \dots +95\text{ °C}$	
DC voltage	$ V_{DC} ^{2)} = 0\text{ V}$	
ESD voltage		
	$V_{ESD}^{3)} = 175\text{ V}$	Machine model.
	$V_{ESD}^{4)} = 250\text{ V}$	Human body model.
Input power @ input port: 2110 ... 2170 MHz	$P_{IN} = 26\text{ dBm}^{5), 6)}$	5 MHz LTE downlink signal (25 RB) for 100000 h @ 55 °C. $P_{IN}$ average – 37 dBm peak. Source and load impedance 50Ω.

1) Not valid for packaging material. Storage temperature for packaging material is  $-25\text{ °C}$  to  $+40\text{ °C}$ .

2) In case of applied DC voltage blocking capacitors are mandatory.

3) According to JESD22-A115B (MM – Machine Model), 10 negative & 10 positive pulses.

4) According to JESD22-A114F (HBM – Human Body Model), 1 negative & 1 positive pulse.

5) Expected lifetime according to accelerated power durability test and wear out models.

6)  $T_{SPEC}$  is the ambient temperature of the PCB at component position. Specified min./max values from section 6 "characteristics" for maximum input power 17dBm are valid for temperature up to  $85\text{ °C}$ .

<b>SAW components</b>	<b>B9622</b>
<b>SAW RF downlink filter</b>	<b>2140 MHz</b>

Data sheet

**8 Transmission coefficient**

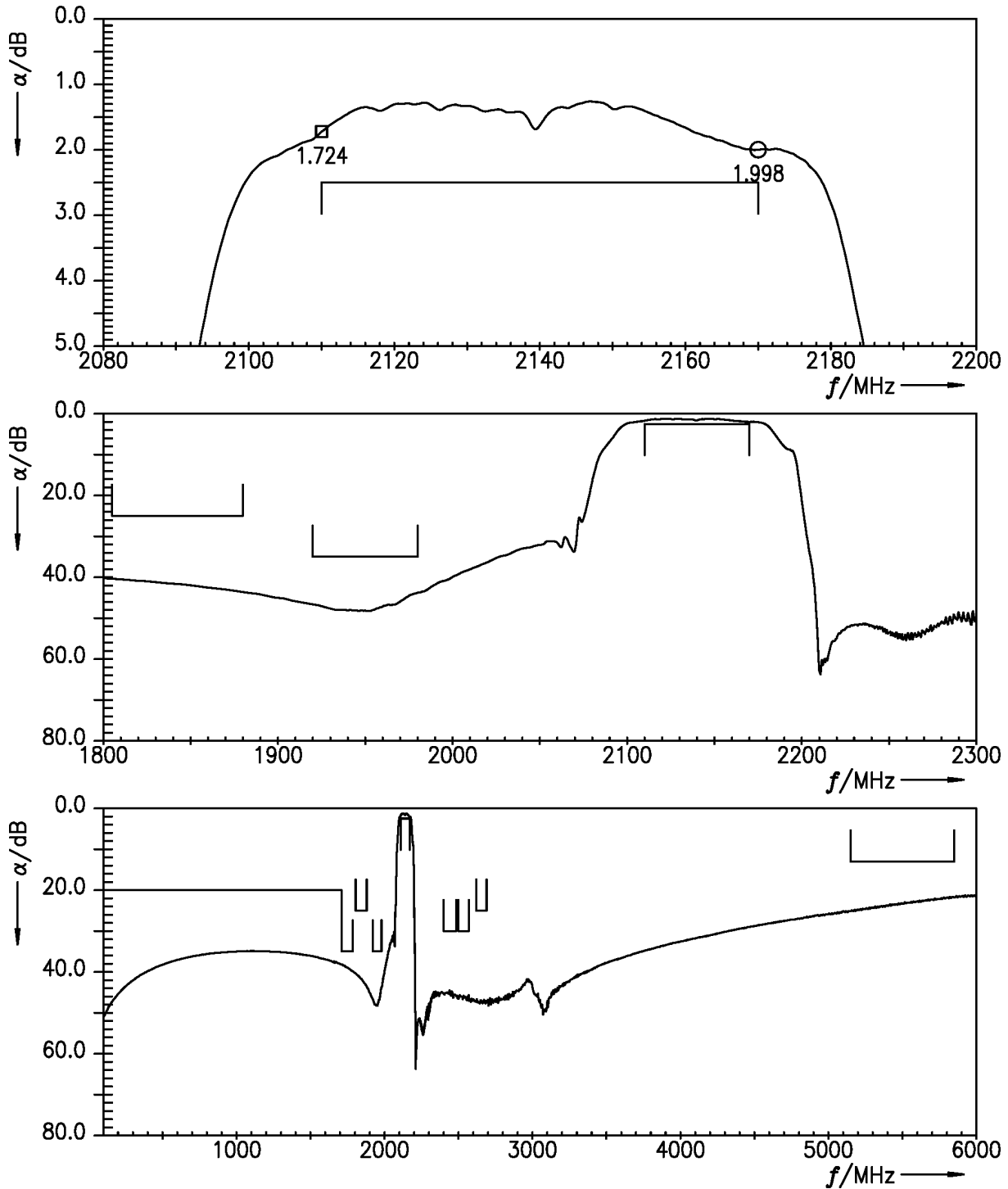

**Figure 4:** Attenuation.

SAW components	B9622
SAW RF downlink filter	2140 MHz

Data sheet

9 Reflection coefficients

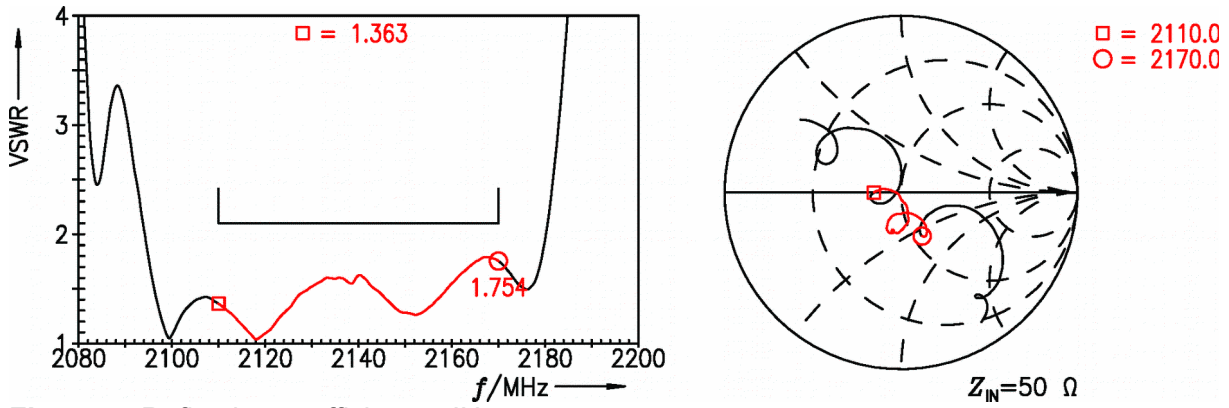

Figure 5: Reflection coefficient at IN port.

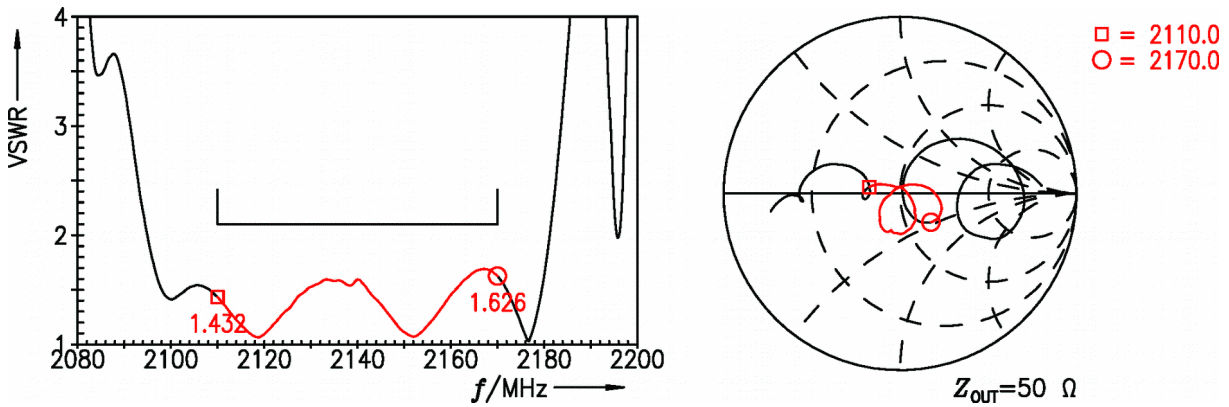

Figure 6: Reflection coefficient at OUT port.

SAW components	B9622
SAW RF downlink filter	2140 MHz

Data sheet

10 EVM

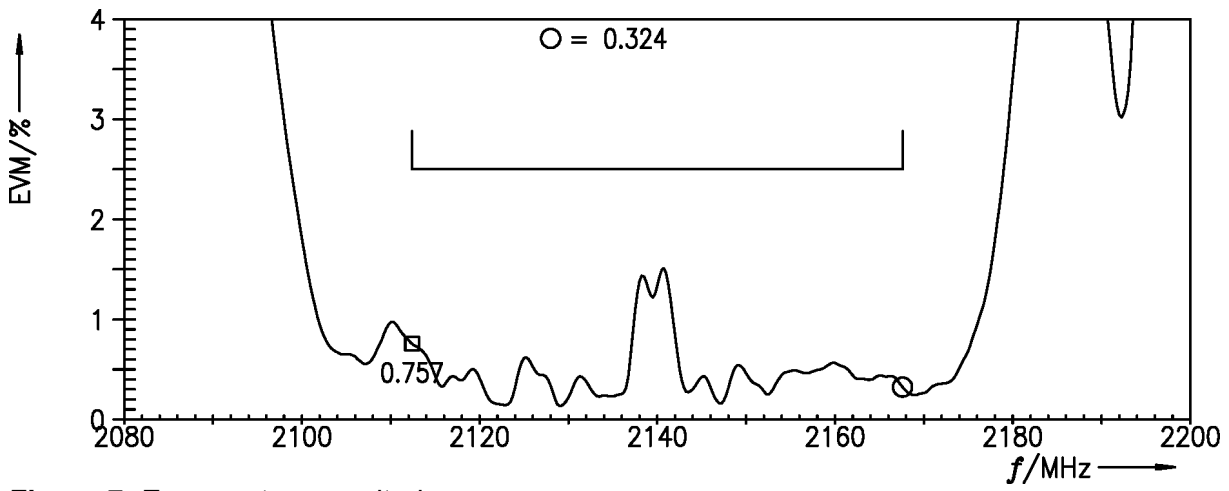
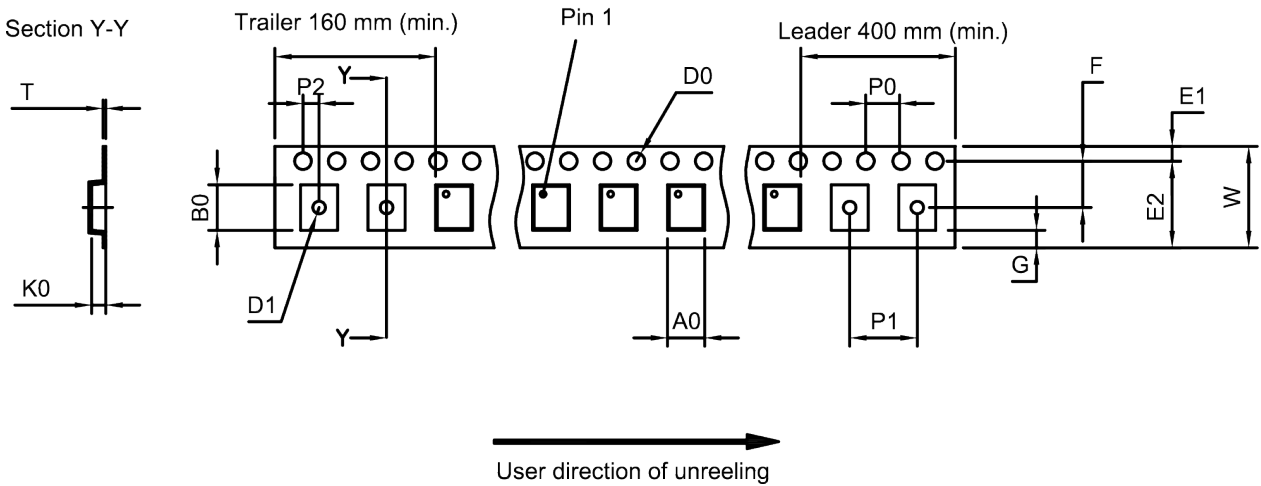

Figure 7: Error vector magnitude.

Data sheet

## 11 Packing material

### 11.1 Tape



**Figure 8:** Drawing of tape (first-angle projection) with tape dimensions according to Table 1.

$A_0$ 1.27±0.05 mm	$E_2$ 6.25 mm (min.)	$P_1$ 4.0±0.1 mm
$B_0$ 1.57±0.05 mm	$F$ 3.5±0.05 mm	$P_2$ 2.0±0.05 mm
$D_0$ 1.5+0.1/-0 mm	$G$ 0.75 mm (min.)	$T$ 0.25±0.03 mm
$D_1$ 0.5±0.1 mm	$K_0$ 0.62±0.05 mm	$W$ 8.0+0.3/-0.1 mm
$E_1$ 1.75±0.1 mm	$P_0$ 4.0±0.1 mm	

**Table 1:** Tape dimensions.

SAW components	B9622
SAW RF downlink filter	2140 MHz

Data sheet

11.2 Reel with diameter of 180 mm

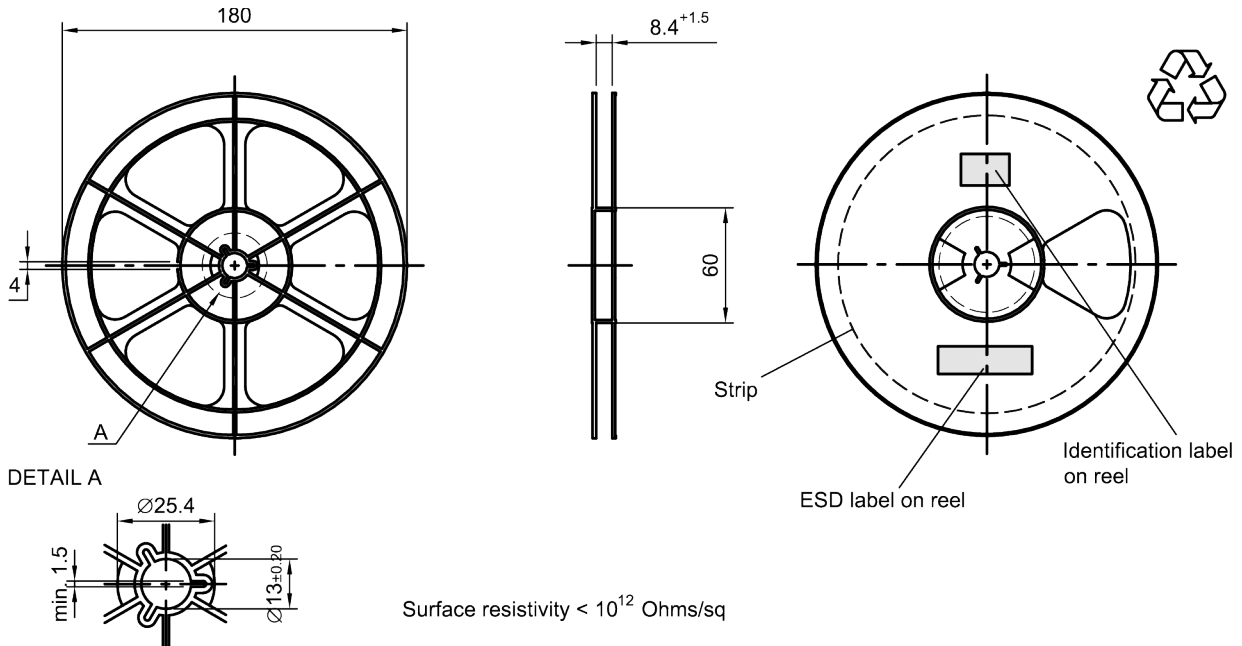

Figure 9: Drawing of reel (first-angle projection) with diameter of 180 mm.

Dimensions [mm]

X = 220+5

Y = 235+5

Sealing area 10±3

Printing on vacuumbag



Vacuumbag

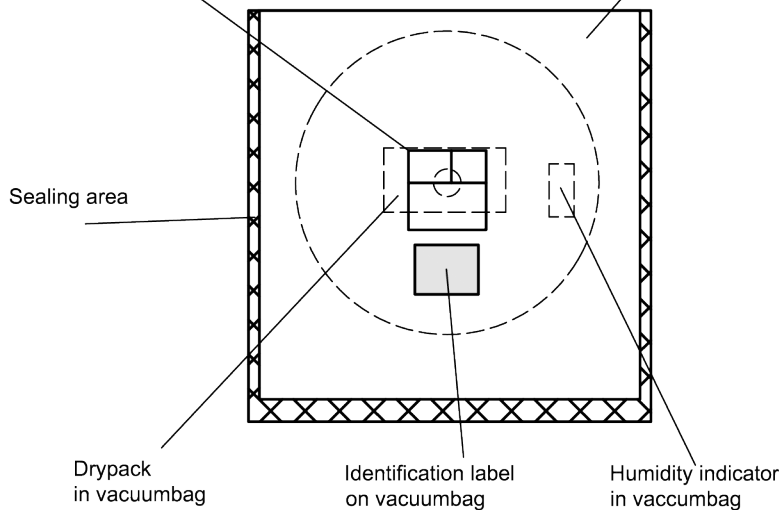

Figure 10: Drawing of moisture barrier bag (MBB) for reel with diameter of 180 mm.



**SAW components** **B9622**  
**SAW RF downlink filter** **2140 MHz**

Data sheet

Dimensions [mm]  
 L = 188  
 B = 188  
 H = 30  
 Tolerance ±5

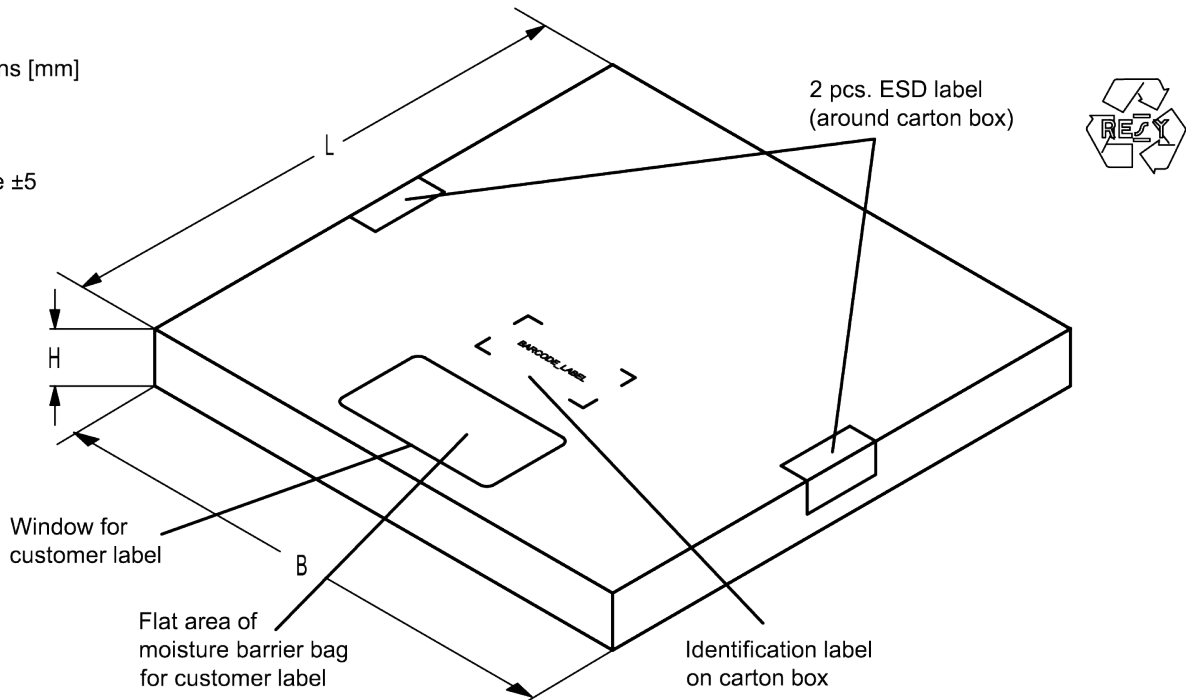

**Figure 11:** Drawing of folding box for reel with diameter of 180 mm.

<b>SAW components</b>	<b>B9622</b>
<b>SAW RF downlink filter</b>	<b>2140 MHz</b>

Data sheet

## 12 Marking

Products are marked with product type number and lot number encoded according to Table 2:

### ■ Type number:

The 4 digit type number of the ordering code, e.g., B3xxxxB**1234**xxxx,  
is encoded by a special BASE32 code into a 3 digit marking.

Example of decoding	type number marking on device	=>	in decimal code.
	<b>16J</b>	=>	<b>1234</b>
	$1 \times 32^2 + 6 \times 32^1 + 18 (=J) \times 32^0$	=	<b>1234</b>

The BASE32 code for product type B9622 is 9CP.

### ■ Lot number:

The last 5 digits of the lot number, e.g., **12345**,  
are encoded based on a special BASE47 code into a 3 digit marking.

Example of decoding	lot number marking on device	=>	in decimal code.
	<b>5UY</b>	=>	<b>12345</b>
	$5 \times 47^2 + 27 (=U) \times 47^1 + 31 (=Y) \times 47^0$	=	<b>12345</b>

Adopted BASE32 code for type number			
Decimal value	Base32 code	Decimal value	Base32 code
0	0	16	G
1	1	17	H
2	2	18	J
3	3	19	K
4	4	20	M
5	5	21	N
6	6	22	P
7	7	23	Q
8	8	24	R
9	9	25	S
10	A	26	T
11	B	27	V
12	C	28	W
13	D	29	X
14	E	30	Y
15	F	31	Z

Adopted BASE47 code for lot number			
Decimal value	Base47 code	Decimal value	Base47 code
0	0	24	R
1	1	25	S
2	2	26	T
3	3	27	U
4	4	28	V
5	5	29	W
6	6	30	X
7	7	31	Y
8	8	32	Z
9	9	33	b
10	A	34	d
11	B	35	f
12	C	36	h
13	D	37	n
14	E	38	r
15	F	39	t
16	G	40	v
17	H	41	\
18	J	42	?
19	K	43	{
20	L	44	}
21	M	45	<
22	N	46	>
23	P		

**Table 2:** Lists for encoding and decoding of marking.

Data sheet

### 13 Soldering profile

The recommended soldering process is in accordance with IEC 60068-2-58 – 3<sup>rd</sup> edit and IPC/JEDEC J-STD-020B.

ramp rate	$\leq 3$ K/s
preheat	125 °C to 220 °C, 150 s to 210 s, 0.4 K/s to 1.0 K/s
$T > 220$ °C	30 s to 70 s
$T > 230$ °C	min. 10 s
$T > 245$ °C	max. 20 s
$T \geq 255$ °C	–
peak temperature $T_{\text{peak}}$	250 °C $\pm 0/-5$ °C
wetting temperature $T_{\text{min}}$	230 °C $\pm 5/-0$ °C for 10 s $\pm 1$ s
cooling rate	$\leq 3$ K/s
soldering temperature $T$	measured at solder pads

**Table 3:** Characteristics of recommended soldering profile for lead-free solder (Sn95.5Ag3.8Cu0.7).

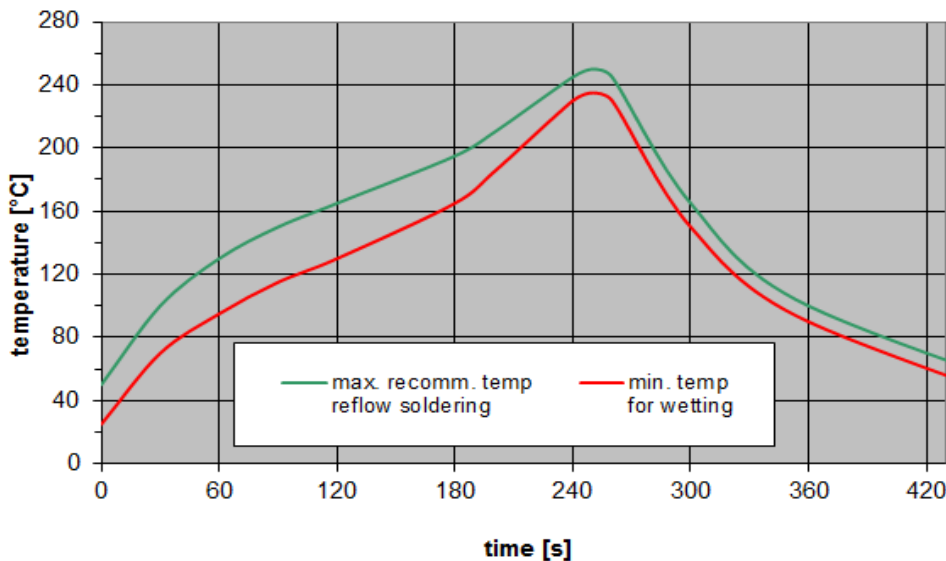

**Figure 12:** Recommended reflow profile for convection and infrared soldering – lead-free solder.

Data sheet

## 14 Annotations

### 14.1 Matching coils

See TDK inductor pdf-catalog <http://www.tdk.co.jp/tefe02/coil.htm#aname1> and Data Library for circuit simulation <http://www.tdk.co.jp/etvcl/index.htm>.

### 14.2 RoHS compatibility

ROHS-compatible means that products are compatible with the requirements according to Art. 4 (substance restrictions) of Directive 2011/65/EU of the European Parliament and of the Council of June 8th, 2011, on the restriction of the use of certain hazardous substances in electrical and electronic equipment ("Directive") with due regard to the application of exemptions as per Annex III of the Directive in certain cases.

### 14.3 Scattering parameters (S-parameters)

The pin/port assignment is available in the headers of the S-parameter files. Please contact your local RF360 sales office.

### 14.4 Ordering codes and packing units

Ordering code	Packing unit
B39212B9622P810	5000 pcs

**Table 4:** Ordering codes and packing units.

Data sheet

## **15 Cautions and warnings**

### **15.1 Display of ordering codes for RF360 products**

The ordering code for one and the same product can be represented differently in data sheets, data books, other publications and the website of RF360, or in order-related documents such as shipping notes, order confirmations and product labels. The varying representations of the ordering codes are due to different processes employed and do not affect the specifications of the respective products. Detailed information can be found on the Internet under [www.rf360jv.com/orderingcodes](http://www.rf360jv.com/orderingcodes).

### **15.2 Material information**

Due to technical requirements components may contain dangerous substances. For information on the type in question please also contact one of our sales offices.

For information on recycling of tapes and reels please contact one of our sales offices.

### **15.3 Moldability**

Before using in overmolding environment, please contact your local RF360 sales office.

### **15.4 Package information**

#### **Landing area**

The printed circuit board (PCB) land pattern (landing area) shown is based on RF360 internal development and empirical data and illustrated for example purposes, only. As customers' SMD assembly processes may have a plenty of variants and influence factors which are not under control or knowledge of RF360, additional careful process development on customer side is necessary and strongly recommended in order to achieve best soldering results tailored to the particular customer needs.

#### **Dimensions**

Unless otherwise specified all dimensions are understood using unit millimeter (mm).

Dimensions do not include burrs.

#### **Projection method**

Unless otherwise specified first-angle projection is applied.

## Important notes

The following applies to all products named in this publication:

1. Some parts of this publication contain **statements about the suitability of our products for certain areas of application**. These statements are based on our knowledge of typical requirements that are often placed on our products in the areas of application concerned. We nevertheless expressly point out **that such statements cannot be regarded as binding statements about the suitability of our products for a particular customer application**. As a rule, RF360 Europe GmbH and its affiliates are either unfamiliar with individual customer applications or less familiar with them than the customers themselves. For these reasons, it is always ultimately incumbent on the customer to check and decide whether an RF360 product with the properties described in the product specification is suitable for use in a particular customer application.
2. We also point out that **in individual cases, a malfunction of electronic components or failure before the end of their usual service life cannot be completely ruled out in the current state of the art, even if they are operated as specified**. In customer applications requiring a very high level of operational safety and especially in customer applications in which the malfunction or failure of an electronic component could endanger human life or health (e.g. in accident prevention or life-saving systems), it must therefore be ensured by means of suitable design of the customer application or other action taken by the customer (e.g. installation of protective circuitry or redundancy) that no injury or damage is sustained by third parties in the event of malfunction or failure of an electronic component.
3. **The warnings, cautions and product-specific notes must be observed.**
4. In order to satisfy certain technical requirements, **some of the products described in this publication may contain substances subject to restrictions in certain jurisdictions (e.g. because they are classed as hazardous)**. Useful information on this will be found in our Material Data Sheets on the Internet ([www.rf360jv.com/material](http://www.rf360jv.com/material)). Should you have any more detailed questions, please contact our sales offices.
5. We constantly strive to improve our products. Consequently, **the products described in this publication may change from time to time**. The same is true of the corresponding product specifications. Please check therefore to what extent product descriptions and specifications contained in this publication are still applicable before or when you place an order. We also **reserve the right to discontinue production and delivery of products**. Consequently, we cannot guarantee that all products named in this publication will always be available.  
The aforementioned does not apply in the case of individual agreements deviating from the foregoing for customer-specific products.