



RF360
Europe GmbH

SAW components

SAW filter

Small cell & femtocell
Band 5 Downlink

Series/type:	B9612
Ordering code:	B39881B9612P810
Date:	May 11, 2017
Version:	2.2

RF360 products mentioned within this document are products of RF360 Europe GmbH and other subsidiaries of RF360 Holdings Singapore Pte. Ltd. (collectively, the "RF360 Subsidiaries").

RF360 Europe GmbH, Anzinger Str. 13, München, Germany

© 2019 RF360 Europe GmbH and/or its affiliated companies. All rights reserved.

These materials, including the information contained herein, may be used only for informational purposes by the customer. The RF360 Subsidiaries assume no responsibility for errors or omissions in these materials or the information contained herein. The RF360 Subsidiaries reserve the right to make changes to the product(s) or information contained herein without notice. The materials and information are provided on an AS IS basis, and the RF360 Subsidiaries assume no liability and make no warranty or representation, either expressed or implied, with respect to the materials, or any output or results based on the use, application, or evaluation of such materials, including, without limitation, with respect to the non-infringement of trademarks, patents, copyrights or any other intellectual property rights or other rights of third parties.

No use of this documentation or any information contained herein grants any license, whether express, implied, by estoppel or otherwise, to any intellectual property rights, including, without limitation, to any patents owned by QUALCOMM Incorporated or any of its subsidiaries.

Not to be used, copied, reproduced, or modified in whole or in part, nor its contents revealed in any manner to others without the express written permission of RF360 Europe GmbH.

Qualcomm is a trademark of Qualcomm Incorporated, registered in the United States and other countries. Other product and brand names may be trademarks or registered trademarks of their respective owners.

This technical data may be subject to U.S. and international export, re-export, or transfer ("export") laws. Diversion contrary to U.S. and international law is strictly prohibited.

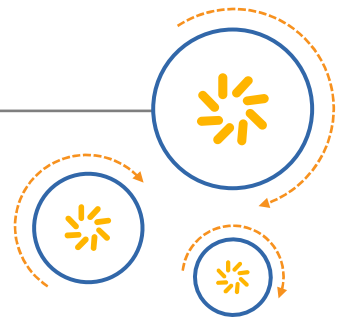

RF360 Europe GmbH
A Qualcomm – TDK Joint Venture

SAW components

SAW filter

Small cell & femtocell
Band 5 Downlink

Series/type:	B9612
Ordering code:	B39881B9612P810
Date:	May 11, 2017
Version:	2.2

RF360 products mentioned within this document are offered by RF360 Europe GmbH and other subsidiaries of RF360 Holdings Singapore Pte. Ltd. (collectively, the “RF360 Subsidiaries”).

RF360 Holdings Singapore Pte. Ltd. is a joint venture of Qualcomm Global Trading Pte. Ltd. and EPCOS AG.

RF360 Europe GmbH, Anzinger Str. 13, München, Germany

© 2017 RF360 Europe GmbH and/or its affiliated companies. All rights reserved.

SAW components**B9612****SAW filter****881.5 MHz**

Data sheet

These materials, including the information contained herein, may be used only for informational purposes by the customer. The RF360 Subsidiaries assume no responsibility for errors or omissions in these materials or the information contained herein. The RF360 Subsidiaries reserve the right to make changes to the product(s) or information contained herein without notice. The materials and information are provided on an AS IS basis, and the RF360 Subsidiaries assume no liability and make no warranty or representation, either expressed or implied, with respect to the materials, or any output or results based on the use, application, or evaluation of such materials, including, without limitation, with respect to the non-infringement of trademarks, patents, copyrights or any other intellectual property rights or other rights of third parties.

No use of this documentation or any information contained herein grants any license, whether express, implied, by estoppel or otherwise, to any intellectual property rights, including, without limitation, to any patents owned by QUALCOMM Incorporated or any of its subsidiaries.

Not to be used, copied, reproduced, or modified in whole or in part, nor its contents revealed in any manner to others without the express written permission of RF360 Europe GmbH.

Qualcomm and Qualcomm RF360 are trademarks of Qualcomm Incorporated, registered in the United States and other countries. RF360 is a trademark of Qualcomm Incorporated. Other product and brand names may be trademarks or registered trademarks of their respective owners.

This technical data may be subject to U.S. and international export, re-export, or transfer ("export") laws. Diversion contrary to U.S. and international law is strictly prohibited.

SAW components	B9612
SAW filter	881.5 MHz

Data sheet

Table of contents

1 Application	4
2 Features	4
3 Package	5
4 Pin configuration	5
5 Matching circuit	6
6 Characteristics	7
7 Maximum ratings	8
8 Transmission coefficient	9
9 Reflection coefficients	10
10 EVM	11
11 Packing material	12
12 Marking	15
13 Soldering profile	16
14 Annotations	17
15 Cautions and warnings	18
Important notes	19

SAW components**B9612****SAW filter****881.5 MHz**

Data sheet

1 Application

- Low-loss RF filter for smallcells
- Usable pass band 25MHz
- No matching network required for operation at 50Ω

2 Features

- Package size 1.4±0.1 mm × 1.1±0.1 mm
- Package height 0.45 mm (max.)
- Approximate weight 3 mg
- RoHS compatible
- Package for Surface Mount Technology (SMT)
- Ni/Au-plated terminals
- Electrostatic Sensitive Device (ESD)
- Moisture Sensitivity Level 2a (MSL2a)

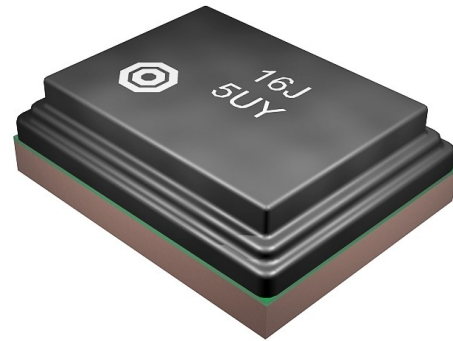

Figure 1: Picture of component with example of product marking.

SAW components **B9612**
SAW filter **881.5 MHz**

Data sheet

3 Package

BOTTOM VIEW

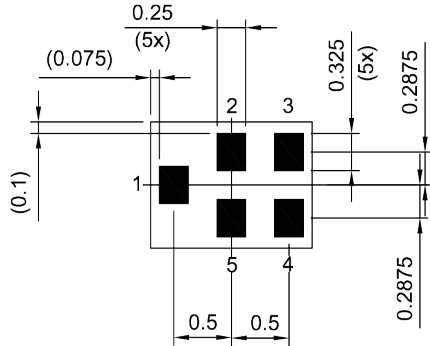

Pad and pitch tolerance ±0.05

4 Pin configuration

- 1 Input
- 4 Output
- 2, 3, 5 Ground

SIDE VIEW

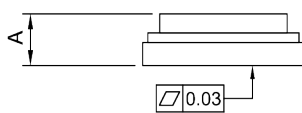

TOP VIEW

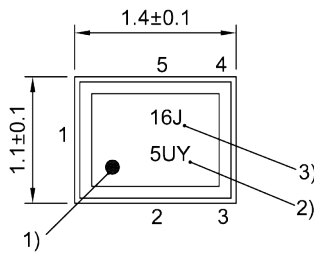

- 1) Marking for pad number 1
- 2) Example of encoded lot number
- 3) Example of encoded filter type number

Land pattern THRU VIEW

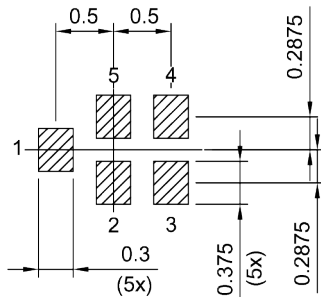

Landing pad tolerance -0.02

Figure 2: Drawing of package with package height A = 0.45 mm (max.). See Sec. Package information (p. 18).

Data sheet

5 Matching circuit

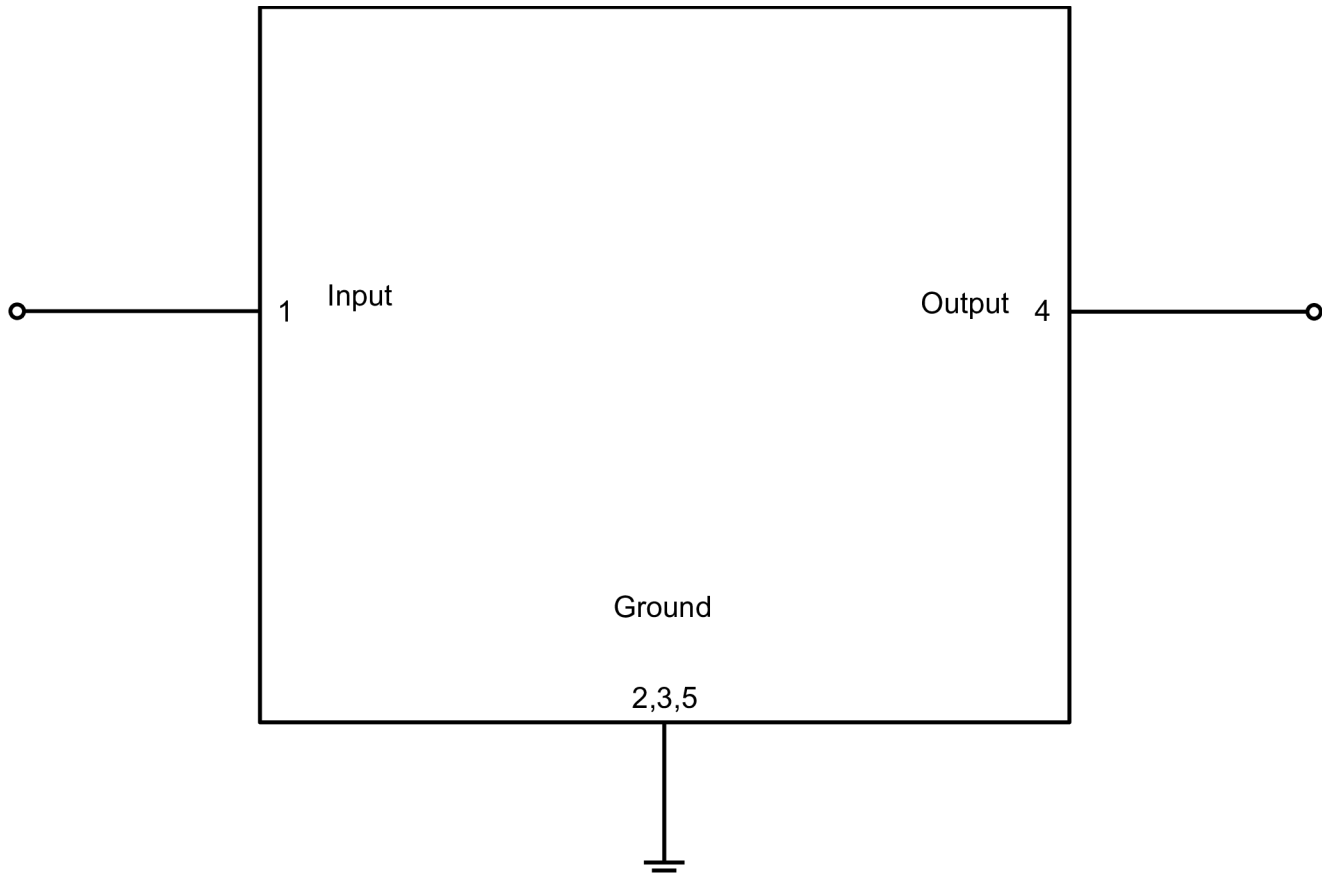

Figure 3: Schematic of matching circuit. No external matching components required.

SAW components

B9612

SAW filter

881.5 MHz

Data sheet

6 Characteristics

Temperature range for specification	T_{SPEC}	= -10 °C ... +85 °C
Input terminating impedance	Z_{IN}	= 50 Ω
Output terminating impedance	Z_{OUT}	= 50 Ω

Characteristics				min. for T_{SPEC}	typ. @ +25 °C	max. for T_{SPEC}		
Center frequency			f_C	—	881.5	—	MHz	
Maximum insertion attenuation								
		869... 894	MHz	α_{max}	—	1.8	2.5	dB
	@ $f_{carrier}$	871.4... 891.6	MHz	$\alpha_{WCDMA,max}^{1)}$	—	1.8	2.2	dB
Amplitude ripple (p-p)				$\Delta\alpha$				
		869... 894	MHz		—	0.7	1.2	dB
Maximum VSWR				VSWR _{max}				
@ input port		869... 894	MHz		—	1.8	2.1	
@ output port		869... 894	MHz		—	1.8	2.1	
Maximum error vector magnitude				EVM _{max}^{2)}}				
		871.4... 891.6	MHz		—	1.9	3.5	%
Minimum attenuation								
		50... 849	MHz	α_{min}	42	51	—	dB
	@ $f_{carrier}$	826.4... 846.6	MHz	$\alpha_{WCDMA,min}^{1)}$	42	51	—	dB
		910... 914	MHz	α_{min}	18	25	—	dB
		914... 950	MHz	α_{min}	25	31	—	dB
		950... 1850	MHz	α_{min}	40	53	—	dB
		1850... 2000	MHz	α_{min}	46	61	—	dB
		2000... 3500	MHz	α_{min}	33	39	—	dB
		3500... 4000	MHz	α_{min}	21	29	—	dB
		4000... 4500	MHz	α_{min}	15	21	—	dB
		4500... 5200	MHz	α_{min}	13	19	—	dB
		5200... 6000	MHz	α_{min}	13	22	—	dB

¹⁾ Attenuation of WCDMA signal ("power transfer function"). Please refer to definition of Power Transfer Function (PTF) of WCDMA signal (p. 17).

²⁾ Error Vector Magnitude (EVM) based on definition in 3GPP TS 25.141.

SAW components

B9612

SAW filter

881.5 MHz

Data sheet

7 Maximum ratings

Operable temperature	$T_{OP} = -40\text{ °C} \dots +95\text{ °C}$	
Storage temperature	$T_{STG}^{1)} = -40\text{ °C} \dots +95\text{ °C}$	
DC voltage	$ V_{DC} ^{2)} = 0\text{ V}$	
ESD voltage	$V_{ESD}^{3)} = 100\text{ V}$	Machine model.
Input power @ input port: 869 ... 894 MHz	$P_{IN} = 15\text{ dBm}^{4)}$	Continuous wave for 100000 h @ 85 °C.

¹⁾ Not valid for packaging material. Storage temperature for packaging material is -25 °C to +40 °C.

²⁾ In case of applied DC voltage blocking capacitors are mandatory.

³⁾ According to JESD22-A115B (MM – Machine Model), 10 negative & 10 positive pulses.

⁴⁾ Expected Life Time according to accelerated power durability simulation and wear out models.

SAW components	B9612
SAW filter	881.5 MHz

Data sheet

8 Transmission coefficient

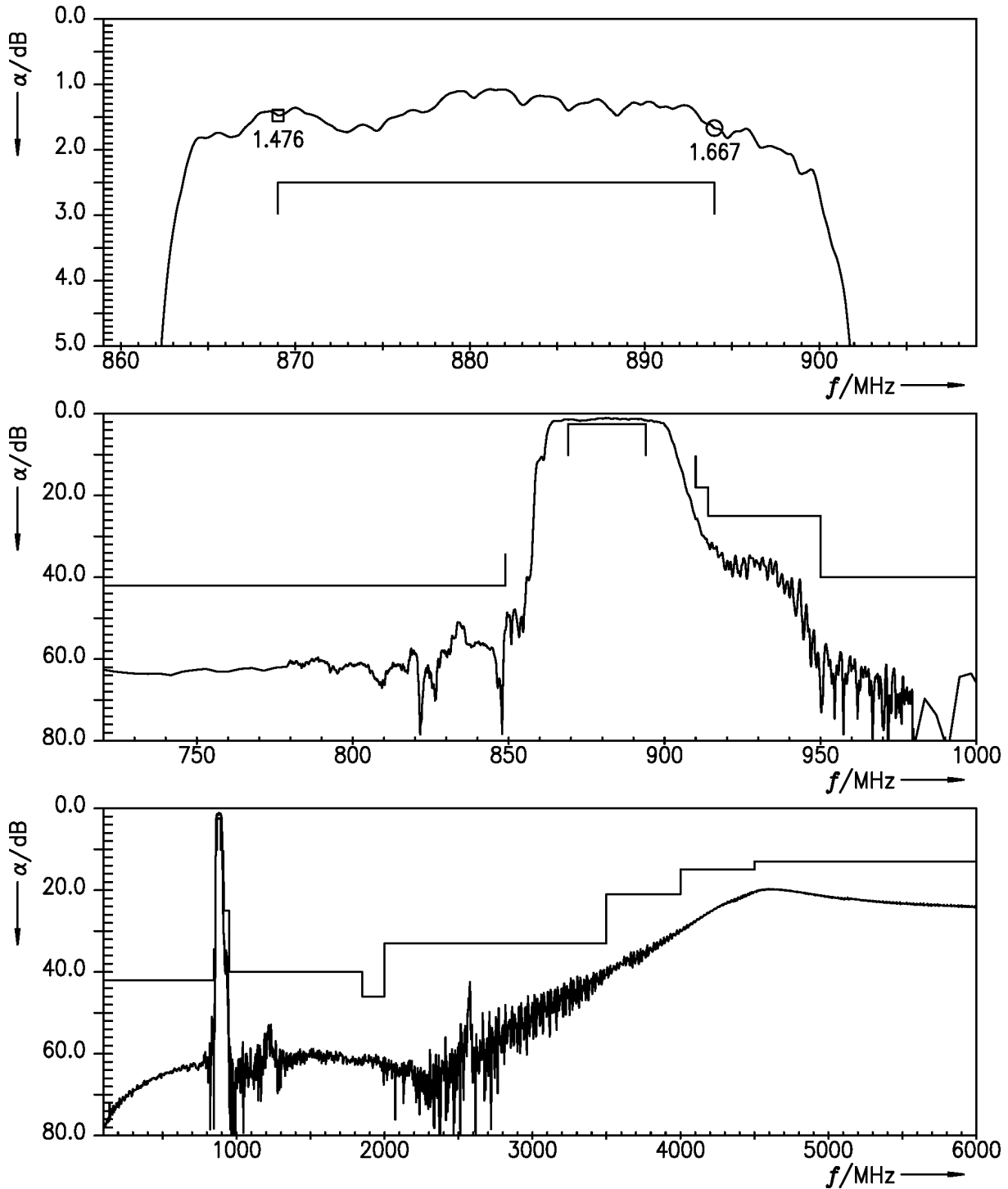

Figure 4: Attenuation.

SAW components	B9612
SAW filter	881.5 MHz

Data sheet

9 Reflection coefficients

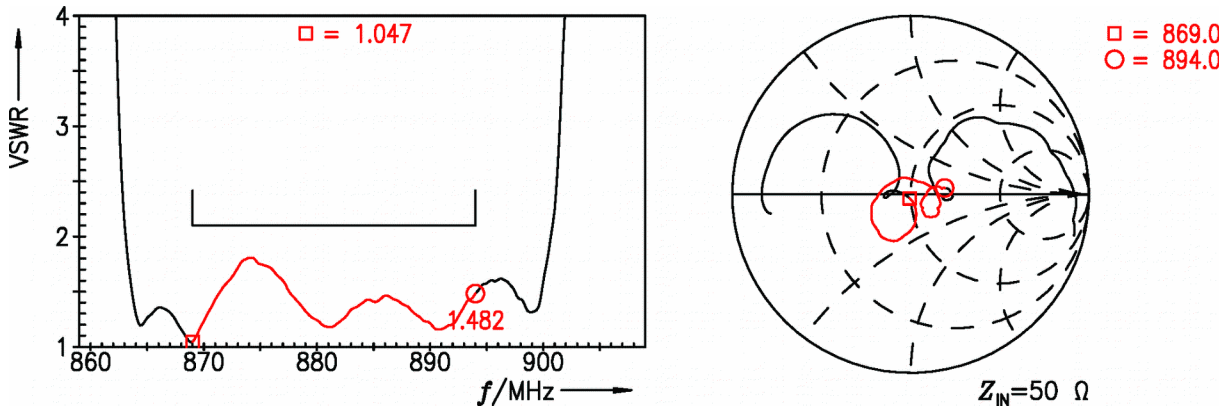

Figure 5: Reflection coefficient at IN port.

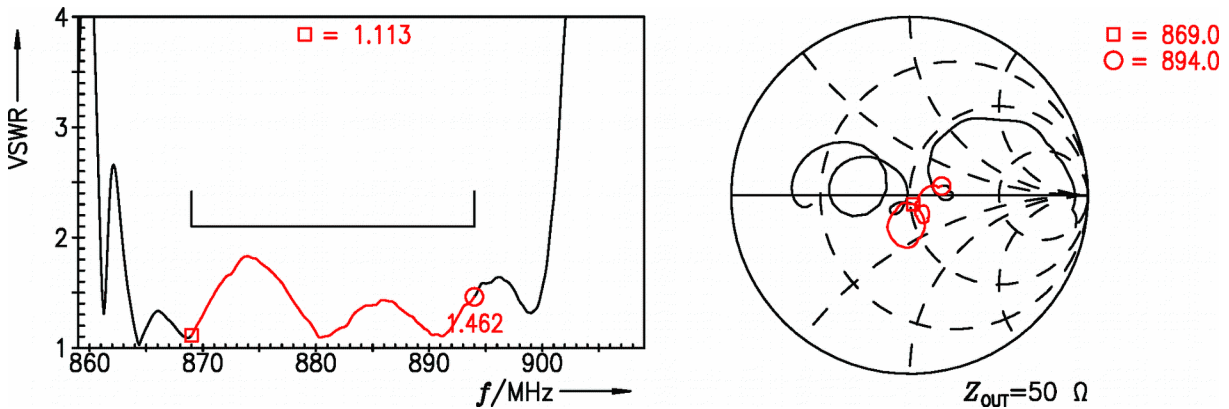

Figure 6: Reflection coefficient at OUT port.

SAW components	B9612
SAW filter	881.5 MHz

Data sheet

10 EVM

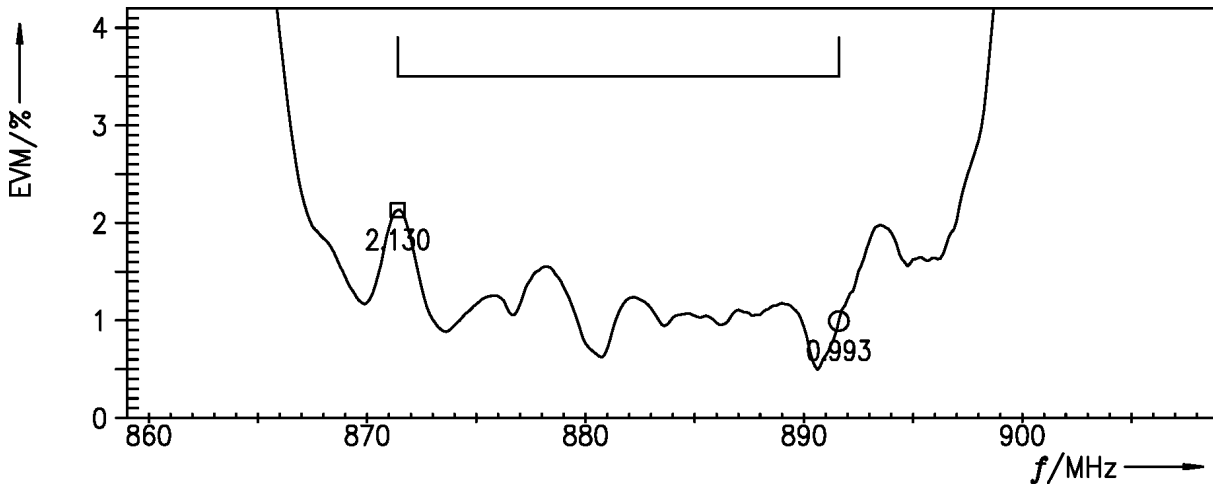

Figure 7: Error vector magnitude.

Data sheet

11 Packing material

11.1 Tape

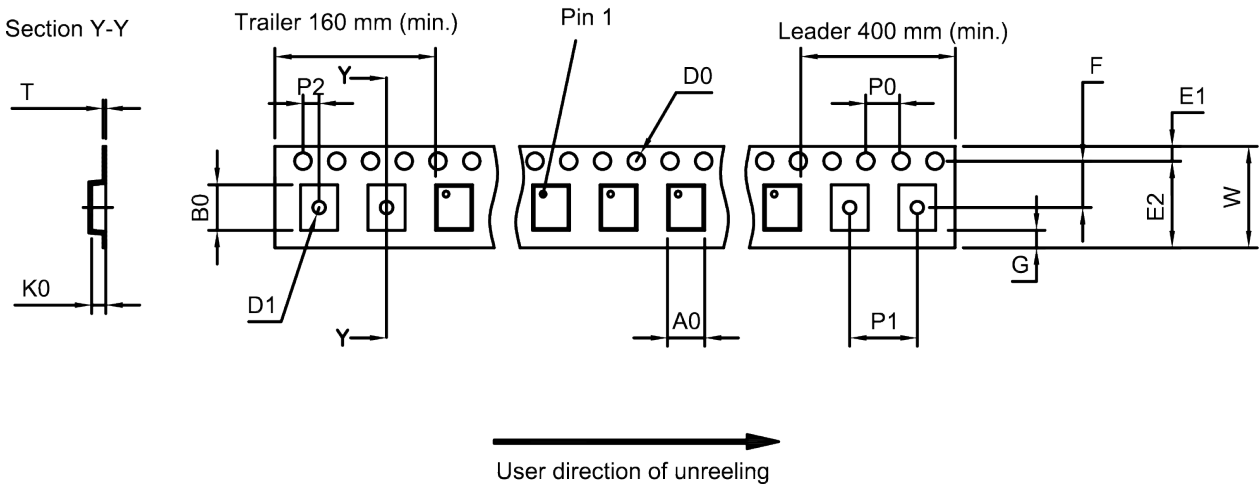

Figure 8: Drawing of tape (first-angle projection) with tape dimensions according to Table 1.

A ₀	1.27±0.05 mm	E ₂	6.25 mm (min.)	P ₁	4.0±0.1 mm
B ₀	1.57±0.05 mm	F	3.5±0.05 mm	P ₂	2.0±0.05 mm
D ₀	1.5+0.1/-0 mm	G	0.75 mm (min.)	T	0.25±0.03 mm
D ₁	0.5±0.1 mm	K ₀	0.62±0.05 mm	W	8.0+0.3/-0.1 mm
E ₁	1.75±0.1 mm	P ₀	4.0±0.1 mm		

Table 1: Tape dimensions.

SAW components	B9612
SAW filter	881.5 MHz

Data sheet

11.2 Reel with diameter of 180 mm

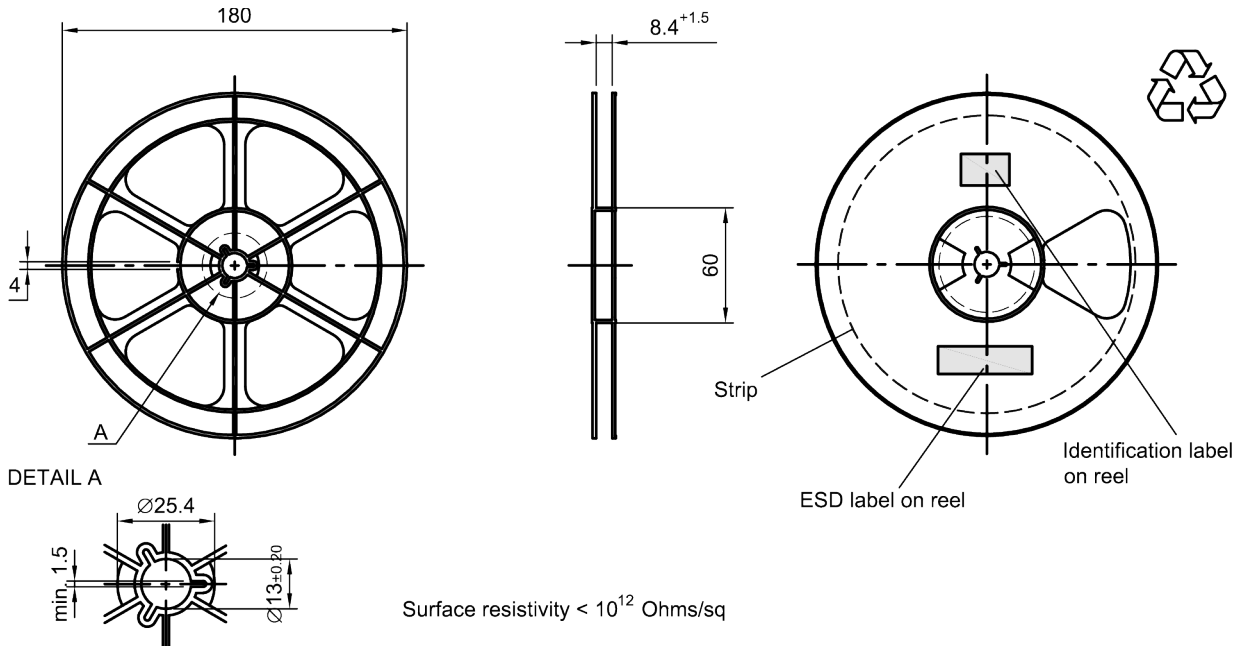

Figure 9: Drawing of reel (first-angle projection) with diameter of 180 mm.

Dimensions [mm]

X = 220+5

Y = 235+5

Sealing area 10±3

Printing on vacuumbag



Vacuumbag

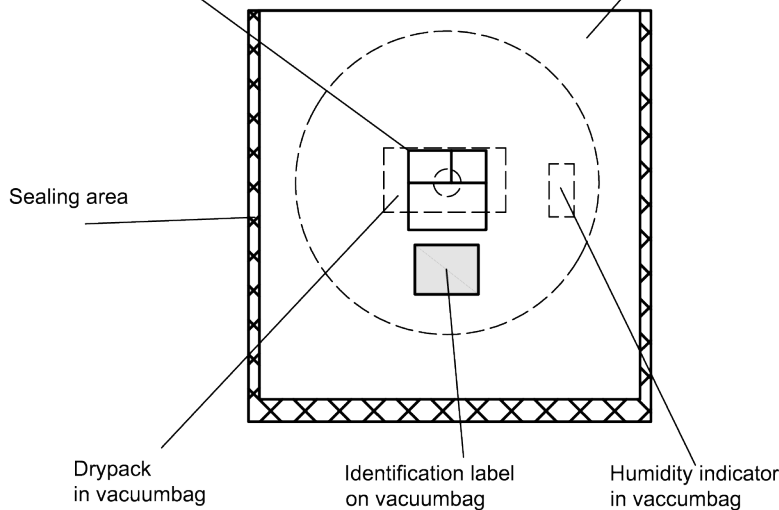

Figure 10: Drawing of moisture barrier bag (MBB) for reel with diameter of 180 mm.

SAW components	B9612
SAW filter	881.5 MHz

Data sheet

Dimensions [mm]
 L = 188
 B = 188
 H = 30
 Tolerance ±5

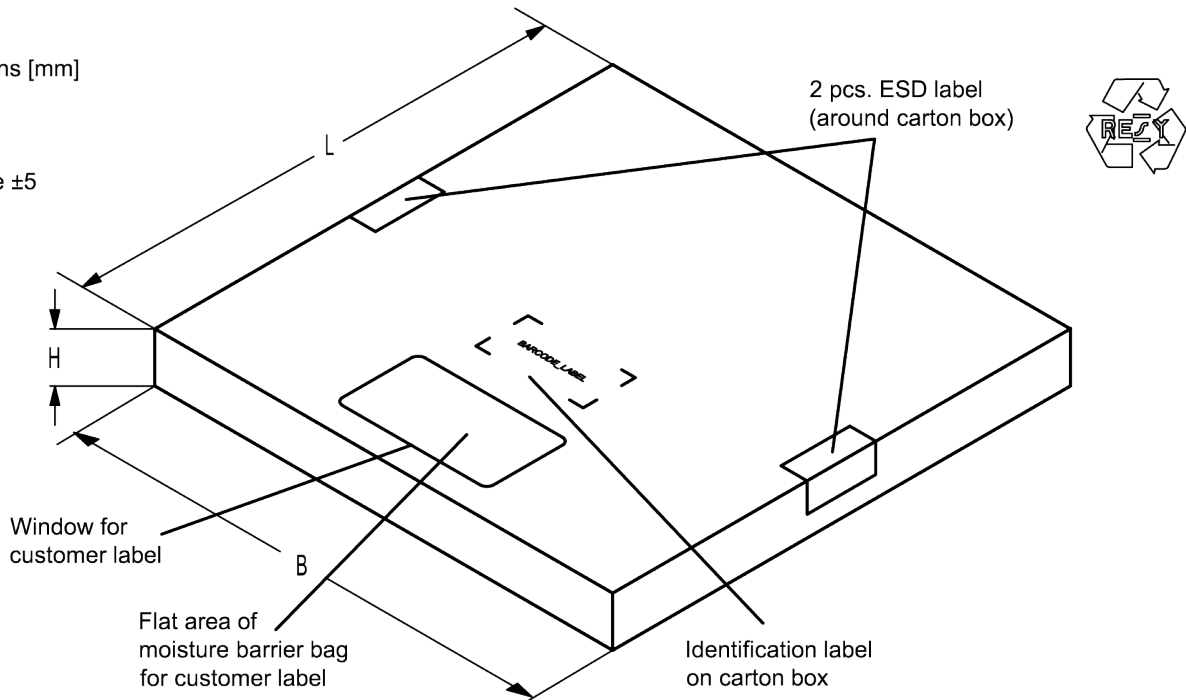

Figure 11: Drawing of folding box for reel with diameter of 180 mm.

SAW components

B9612

SAW filter

881.5 MHz

Data sheet

12 Marking

Products are marked with product type number and lot number encoded according to Table 2:

■ Type number:

The 4 digit type number of the ordering code, e.g., B3xxxxB**1234**xxxx,
is encoded by a special BASE32 code into a 3 digit marking.

Example of decoding	type number marking on device	in decimal code.
	16J	1234
	$1 \times 32^2 + 6 \times 32^1 + 18 (=J) \times 32^0$	1234

The BASE32 code for product type B9612 is 9CC.

■ Lot number:

The last 5 digits of the lot number, e.g., **12345**,
are encoded based on a special BASE47 code into a 3 digit marking.

Example of decoding lot number marking on device		in decimal code.
	5UY	12345
	$5 \times 47^2 + 27 (=U) \times 47^1 + 31 (=Y) \times 47^0$	12345

Adopted BASE32 code for type number			
Decimal value	Base32 code	Decimal value	Base32 code
0	0	16	G
1	1	17	H
2	2	18	J
3	3	19	K
4	4	20	M
5	5	21	N
6	6	22	P
7	7	23	Q
8	8	24	R
9	9	25	S
10	A	26	T
11	B	27	V
12	C	28	W
13	D	29	X
14	E	30	Y
15	F	31	Z

Adopted BASE47 code for lot number			
Decimal value	Base47 code	Decimal value	Base47 code
0	0	24	R
1	1	25	S
2	2	26	T
3	3	27	U
4	4	28	V
5	5	29	W
6	6	30	X
7	7	31	Y
8	8	32	Z
9	9	33	b
10	A	34	d
11	B	35	f
12	C	36	h
13	D	37	n
14	E	38	r
15	F	39	t
16	G	40	v
17	H	41	\
18	J	42	?
19	K	43	{
20	L	44	}
21	M	45	<
22	N	46	>
23	P		

Table 2: Lists for encoding and decoding of marking.

SAW components

B9612

SAW filter

881.5 MHz

Data sheet

13 Soldering profile

The recommended soldering process is in accordance with IEC 60068-2-58 – 3rd edit and IPC/JEDEC J-STD-020B.

ramp rate	≤ 3 K/s
preheat	125 °C to 220 °C, 150 s to 210 s, 0.4 K/s to 1.0 K/s
$T > 220$ °C	30 s to 70 s
$T > 230$ °C	min. 10 s
$T > 245$ °C	max. 20 s
$T \geq 255$ °C	–
peak temperature T_{peak}	250 °C ± 5 °C
wetting temperature T_{min}	230 °C ± 5 °C for 10 s ± 1 s
cooling rate	≤ 3 K/s
soldering temperature T	measured at solder pads

Table 3: Characteristics of recommended soldering profile for lead-free solder (Sn95.5Ag3.8Cu0.7).

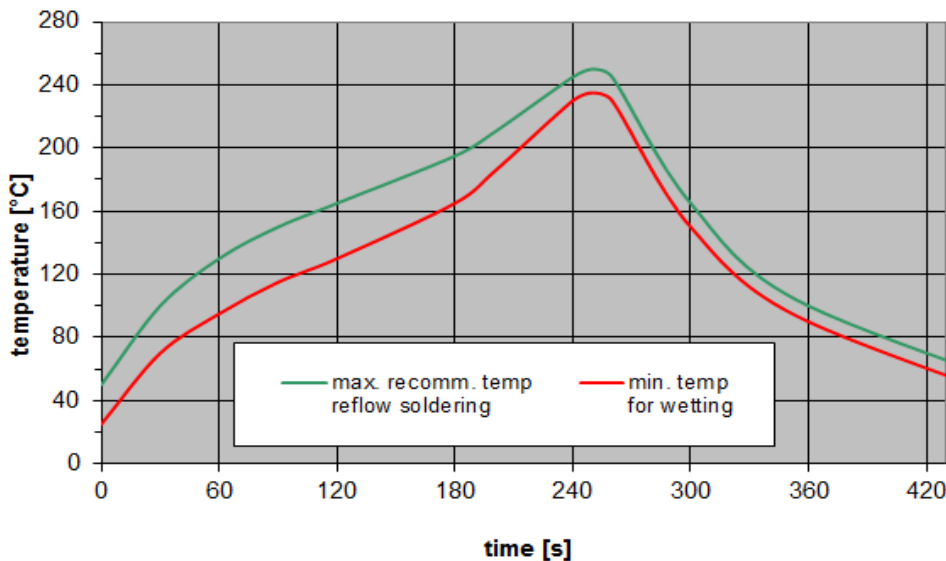

Figure 12: Recommended reflow profile for convection and infrared soldering – lead-free solder.

Data sheet

14 Annotations

14.1 Matching coils

See TDK inductor pdf-catalog <http://www.tdk.co.jp/tefe02/coil.htm#aname1> and Data Library for circuit simulation <http://www.tdk.co.jp/etvcl/index.htm>.

14.2 Power Transfer Function (PTF) of WCDMA signal

Attenuation of WCDMA signal, α_{WCDMA} , is defined by

$$\alpha_{\text{WCDMA}}(f_{\text{carrier}}) = 10 \log_{10} \left| \frac{1}{\text{PTF}(f_{\text{carrier}})} \right| \text{dB}$$

and

$$\text{PTF}(f_{\text{carrier}}) = \int_{-\infty}^{+\infty} |S_{21}(f) H_{\text{RRC}}(f - f_{\text{carrier}})|^2 df$$

with f_{carrier} according to 3GPP TS 25.101 (e.g., for the WCDMA B8 pass band, f_{carrier} ranges from 882.4 MHz to 912.6 MHz which correspond to the lowest and highest TX channels, respectively). $H_{\text{RRC}}(f)$ is the transfer function of the root-raised cosine transmit pulse shaping filter according to 3GPP TS 25.101 using the normalization

$$\int_{-\infty}^{+\infty} |H_{\text{RRC}}(f)|^2 df = 1 \quad .$$

14.3 RoHS compatibility

ROHS-compatible means that products are compatible with the requirements according to Art. 4 (substance restrictions) of Directive 2011/65/EU of the European Parliament and of the Council of June 8th, 2011, on the restriction of the use of certain hazardous substances in electrical and electronic equipment ("Directive") with due regard to the application of exemptions as per Annex III of the Directive in certain cases.

14.4 Scattering parameters (S-parameters)

The pin/port assignment is available in the headers of the S-parameter files. Please contact your local RF360 sales office.

14.5 Ordering codes and packing units

Ordering code	Packing unit
B39881B9612P810	5000 pcs

Table 4: Ordering codes and packing units.

Data sheet

15 Cautions and warnings

15.1 Display of ordering codes for RF360 products

The ordering code for one and the same product can be represented differently in data sheets, data books, other publications and the website of RF360, or in order-related documents such as shipping notes, order confirmations and product labels. The varying representations of the ordering codes are due to different processes employed and do not affect the specifications of the respective products. Detailed information can be found on the Internet under www.rf360jv.com/orderingcodes.

15.2 Material information

Due to technical requirements components may contain dangerous substances. For information on the type in question please also contact one of our sales offices.

For information on recycling of tapes and reels please contact one of our sales offices.

15.3 Moldability

Before using in overmolding environment, please contact your local RF360 sales office.

15.4 Package information

Landing area

The printed circuit board (PCB) land pattern (landing area) shown is based on RF360 internal development and empirical data and illustrated for example purposes, only. As customers' SMD assembly processes may have a plenty of variants and influence factors which are not under control or knowledge of RF360, additional careful process development on customer side is necessary and strongly recommended in order to achieve best soldering results tailored to the particular customer needs.

Dimensions

Unless otherwise specified all dimensions are understood using unit millimeter (mm).

Dimensions do not include burrs.

Projection method

Unless otherwise specified first-angle projection is applied.

Important notes

The following applies to all products named in this publication:

1. Some parts of this publication contain **statements about the suitability of our products for certain areas of application**. These statements are based on our knowledge of typical requirements that are often placed on our products in the areas of application concerned. We nevertheless expressly point out **that such statements cannot be regarded as binding statements about the suitability of our products for a particular customer application**. As a rule, RF360 Europe GmbH and its affiliates are either unfamiliar with individual customer applications or less familiar with them than the customers themselves. For these reasons, it is always ultimately incumbent on the customer to check and decide whether an RF360 product with the properties described in the product specification is suitable for use in a particular customer application.
2. We also point out that **in individual cases, a malfunction of electronic components or failure before the end of their usual service life cannot be completely ruled out in the current state of the art, even if they are operated as specified**. In customer applications requiring a very high level of operational safety and especially in customer applications in which the malfunction or failure of an electronic component could endanger human life or health (e.g. in accident prevention or life-saving systems), it must therefore be ensured by means of suitable design of the customer application or other action taken by the customer (e.g. installation of protective circuitry or redundancy) that no injury or damage is sustained by third parties in the event of malfunction or failure of an electronic component.
3. **The warnings, cautions and product-specific notes must be observed.**
4. In order to satisfy certain technical requirements, **some of the products described in this publication may contain substances subject to restrictions in certain jurisdictions (e.g. because they are classed as hazardous)**. Useful information on this will be found in our Material Data Sheets on the Internet (www.rf360jv.com/material). Should you have any more detailed questions, please contact our sales offices.
5. We constantly strive to improve our products. Consequently, **the products described in this publication may change from time to time**. The same is true of the corresponding product specifications. Please check therefore to what extent product descriptions and specifications contained in this publication are still applicable before or when you place an order. We also **reserve the right to discontinue production and delivery of products**. Consequently, we cannot guarantee that all products named in this publication will always be available.
The aforementioned does not apply in the case of individual agreements deviating from the foregoing for customer-specific products.